

Insulated Cover

Plintlock
Coperchio

Abdeckkappen

HE4/3 & HE4/5

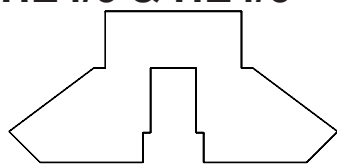

HE4/3

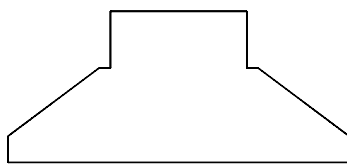

HE4/5

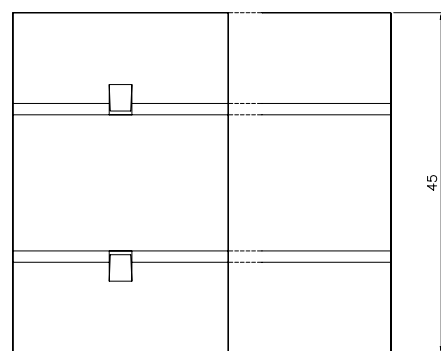
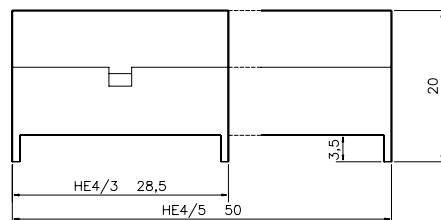
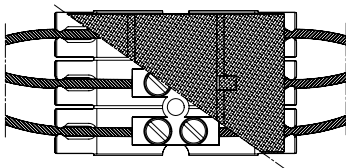
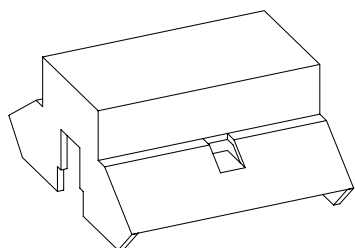

HE6/3 & HE6/5

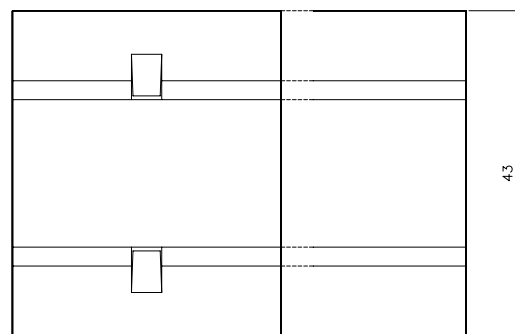
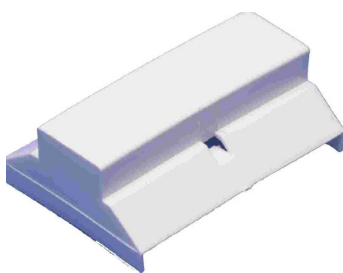
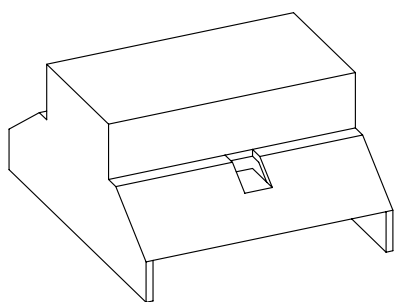
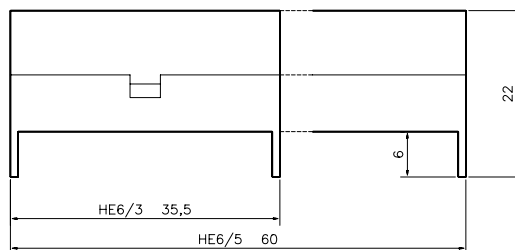
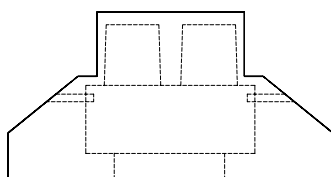

The insulated covers provide as a touch safe cover to terminal blocks. The covers are easy to attach as they are of snap on type. Colour white but on request also in black. **HE4/3 & HE4/5** will fit terminal blocks of type **HE4HN & HE4EH**. **HE4/3** will fit 2 & 3 pole terminal blocks. **HE4/3** can also be mounted on a 12-pole terminal block by using 4 pieces in a row. The insulated cover **HE4/3** can be used together with Cable Grip **DH12-10**. **HE4/5** will fit 4 & 5 pole terminal blocks. The insulated covers **HE6/3 & HE6/5** will fit terminal blocks of type **HE6N, HE6H & HE6S**. **HE6/3** will fit 2 & 3 pole terminal blocks. **HE6/5** will fit 4 & 5 pole terminal blocks.

Plintlocken tjänar som beröringskydd till kopplingsplint. Plintlocket fästs med ett lätt tryck & hålls fast med ett snäppfäste. Plintlocket levereras standard i vit plast men på förfrågan även i svart. Plintlock **HE4/3 & HE4/5** passar till kopplingsplint av typ **HE4HN & HE4EH**. **HE4/3** passar till 2 & 3 polig plint men kan även monteras 4 st i rad upp till 12-poler och kombineras med trådhållare **DH12-10**. **HE4/5** passar till 4 & 5 polig plint. Plintlock **HE6/3 & HE6/5** passar till kopplingsplint av typ **HE6N, HE6H & HE6S**. **HE6/3** & passar till 2 & 3 poligt utförande. **HE6/5** passar till 4 & 5 polig plint.

Die Abdeckkappen dienen zur berührungssicheren Abdeckung der Klemmen. Die Abdeckkappe wird einfach aufgedrückt und rastet unverlierbar in die Klemmleiste ein. Die **HE4/3 & HE4/5** sind passend für alle **HE4HN & HE4EH** Typen. **HE4/3** ist passend für 2 & 3 polige Klemmen. Es können aber auch 4 Stück an einer 12-poligen Klemme aneinandergereiht werden. Die Abdeckkappe können zusammen mit Drahtalterplatte **DH12-10** verwendet werden. **HE4/5** ist passend für 4 & 5 polige Klemmen. Die **HE6/3 & HE6/5** sind passend für alle **HE6N, HE6H & HE6S** Typen. **HE6/3** ist passend für 2 & 3 polige Klemmen. **HE6/5** ist passend für 4 & 5 polige Klemmen.